

NATADORA

BYRON BAY MODULAR SOFA

by cameron foggo

The brief for Byron Bay sofa was to design an elegant, simple sofa which offered luxury for smaller living spaces. Designing compact sofas which still have character and presence is always a challenge, where balance and proportions become crucial.

Avoiding multiple layers and surplus cushions allowed us to reduce the form down to essential elements, which were then curved artfully to achieve comfort and visual fluidity. The solid wood plinth adds a clear outline to the form - a study in minimalist luxury.



AVAILABLE IN THE FOLLOWING CONFIGURATIONS

byron bay sofa
 850W x 800D x 740H
 1600W x 800D x 740H
 1800W x 800D x 740H
 2000W x 800D x 740H

department modular components
 1300W x 800D x 740H 1 arm
 1600W x 800D x 740H 1 arm
 800W x 1400D x 740H chaise
 800W x 1600D x 740H chaise

frame : powder coated steel (matte black) /
 timber base frame in american oak, american walnut
 or american oak stained black.

filling : high density polyurethane foam, duck feather and fiber
 on all cushioning.

see our fabric and leather sample box for available options

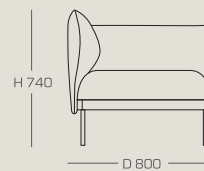

Byron Bay chair

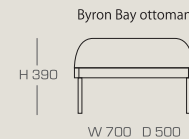
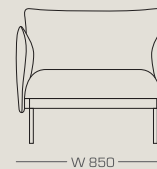

Byron Bay 160

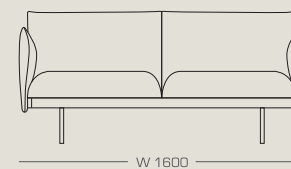

Byron Bay 180

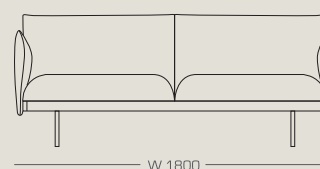

Byron Bay 200

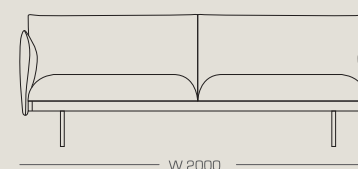

Byron Bay 130 1-arm LHF/RHF

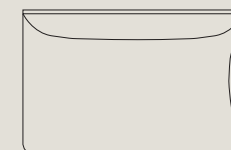
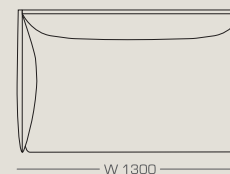

Byron Bay 160 1-arm LHF/RHF

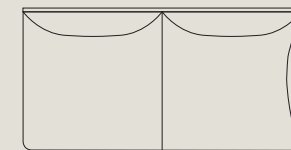
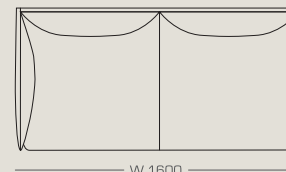

Byron Bay 140 chaise LHF/RHF

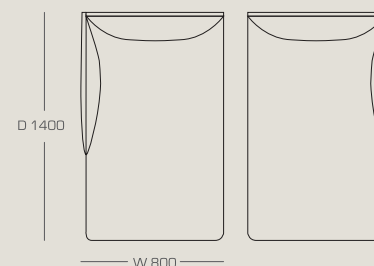

Byron Bay 160 chaise LHF/RHF

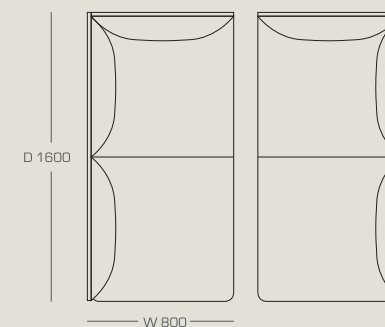

NATADORA

